



Bakery China

2017第二届中国国际焙烤展览会

2017年5月10-13日(四天) 上海新国际博览中心(浦东新区龙阳路2345号)

Date: May 10th-13th, 2017 Venue: Shanghai New Int'l Expo Center (SNIEC)

电话: 010-63430880 63430990 传真: 010-63430660

邮箱: info@bakerychina.com

网址: www.bakerychina.com

威伦天然色素展位: E3 K10 2号门

E1 原料/Ingredient

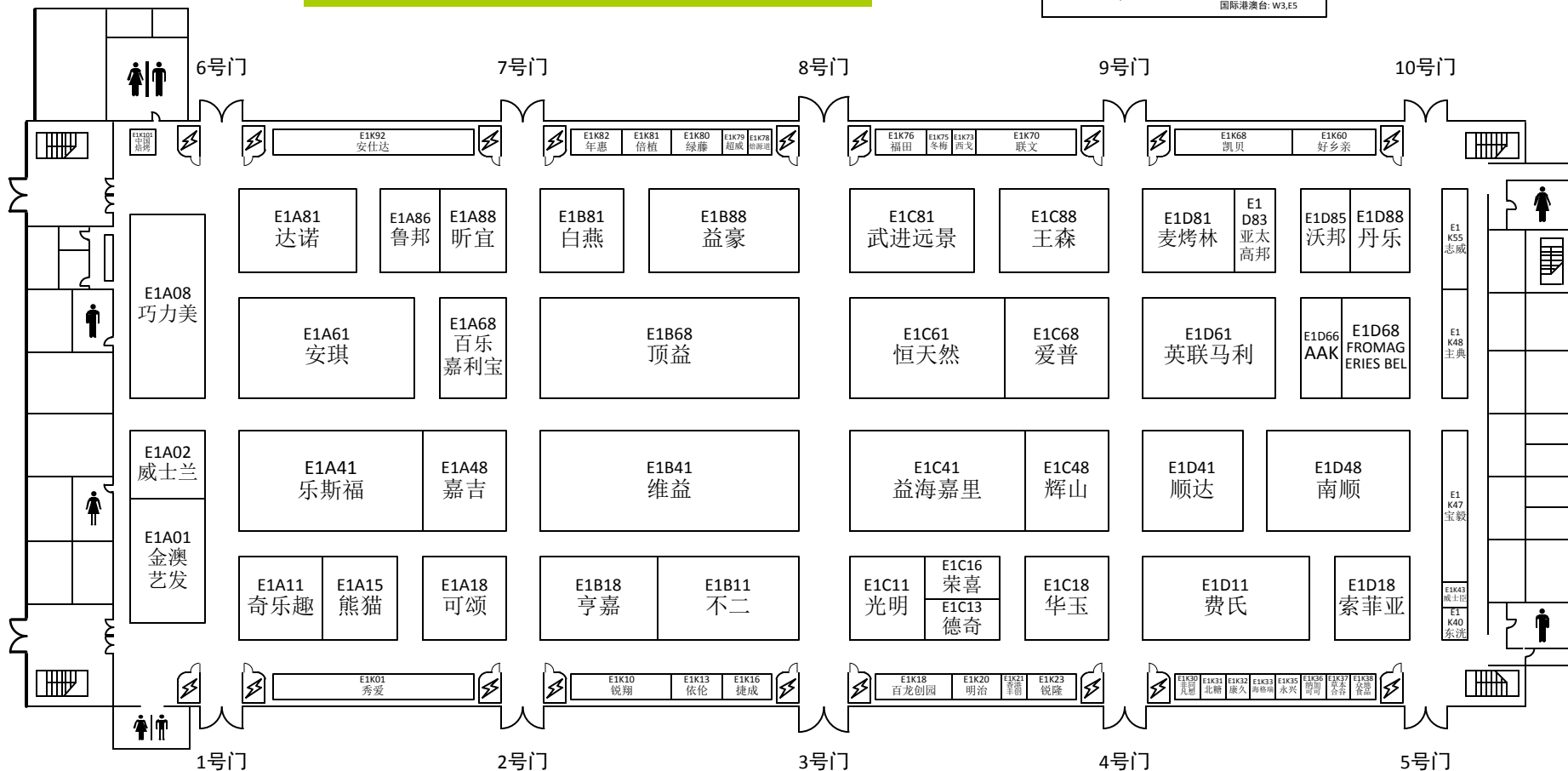
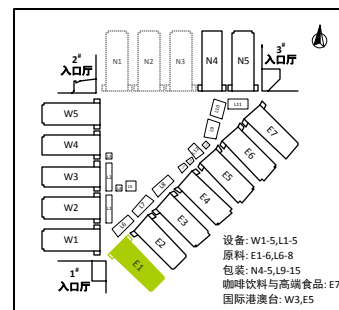



Bakery China

2017第二届中国国际焙烤展览会

2017年5月10-13日(四天) 上海新国际博览中心(浦东新区龙阳路2345号)

Date: May 10th-13th, 2017 Venue: Shanghai New Int'l Expo Center (SNIEC)

电话: 010-63430880 63430990 传真: 010-63430660

邮箱: info@bakerychina.com

网址: www.bakerychina.com

威伦天然色素展位: E3 K10 2号门

E2 原料/Ingredient

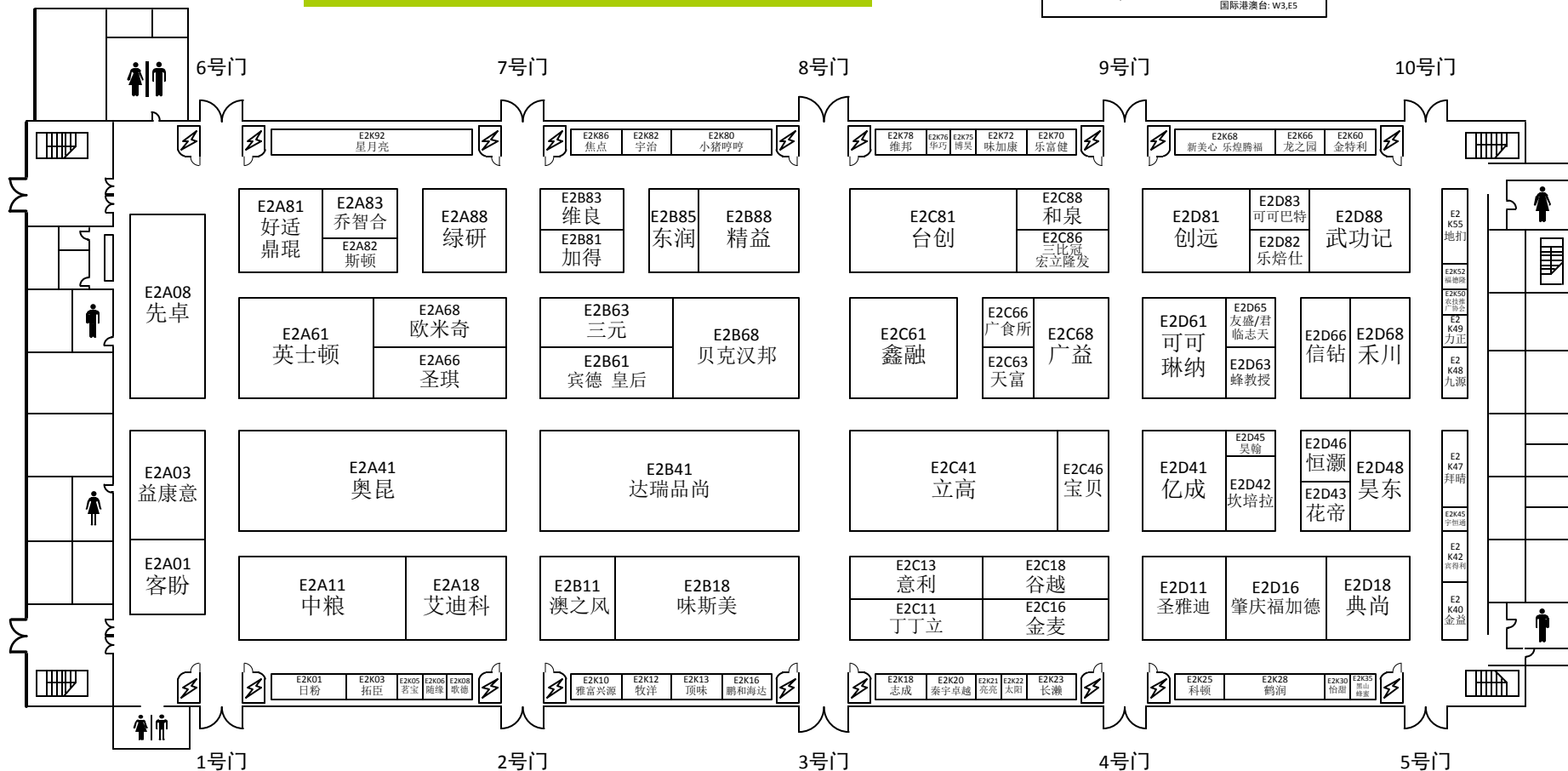
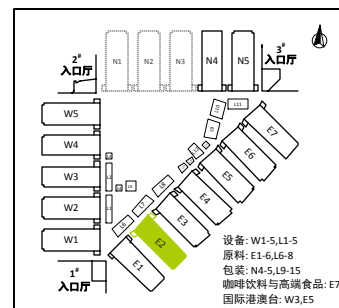



Bakery China

2017第二届中国国际焙烤展览会

2017年5月10-13日(四天) 上海新国际博览中心 (浦东新区龙阳路2345号)

Date: May 10th-13th, 2017 Venue: Shanghai New Int'l Expo Center (SNIEC)

电话: 010-63430880 63430990 传真: 010-63430660

邮箱: info@bakerychina.com

网址: www.bakerychina.com

威伦天然色素展位: E3 K10 2号门

E3 原料/Ingredient

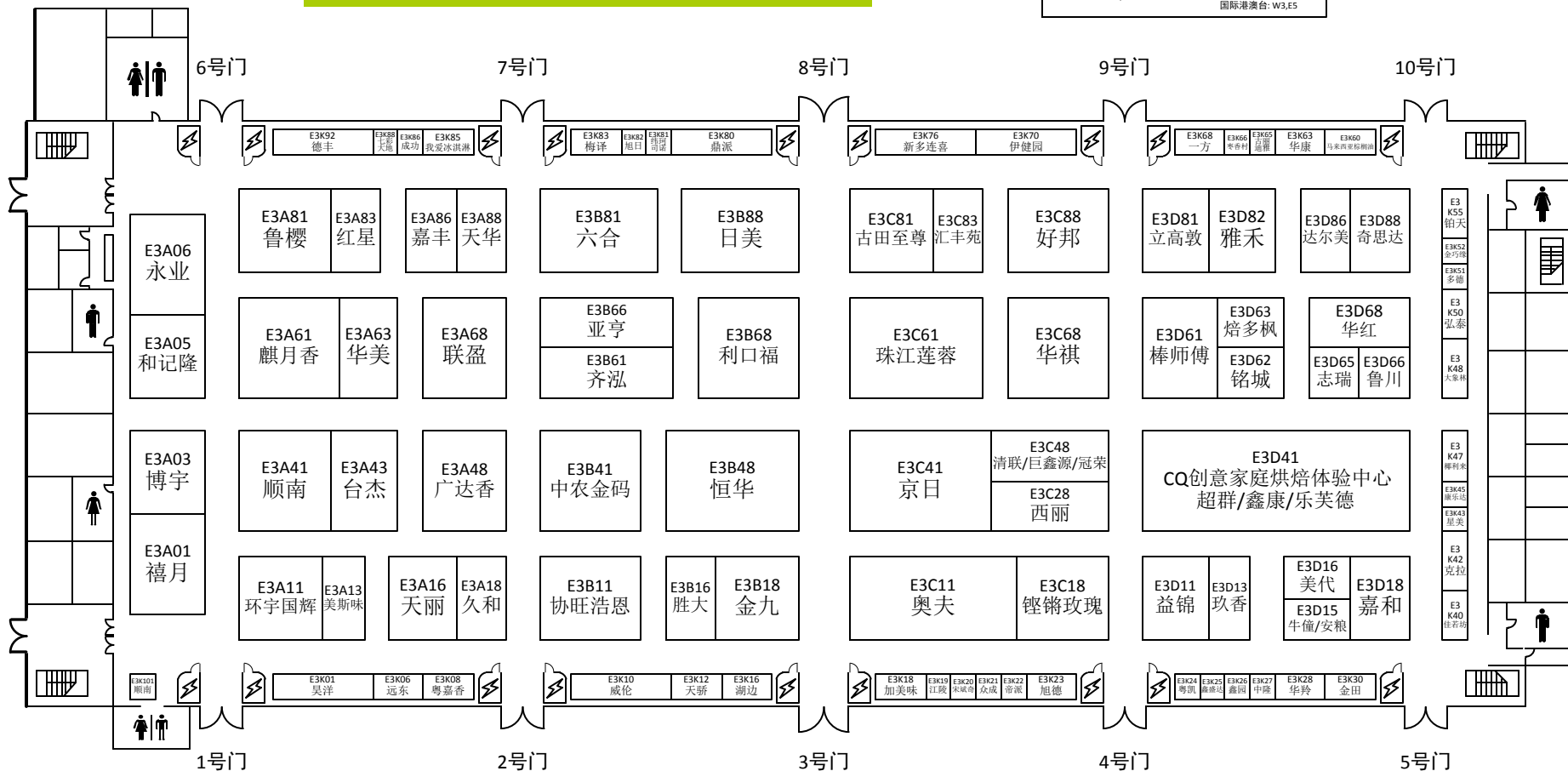
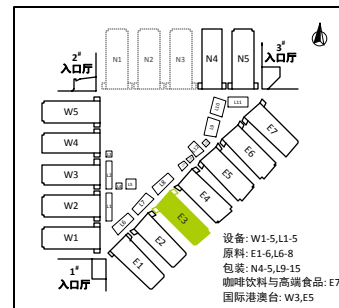



Bakery China

2017第二届中国国际焙烤展览会

2017年5月10-13日(四天) 上海新国际博览中心(浦东新区龙阳路2345号)

Date: May 10th-13th,2017 Venue: Shanghai New Int'l Expo Center (SNIEC)

电话: 010-63430880 63430990 传真: 010-63430660

邮箱: info@bakerychina.com

网址: www.bakerychina.com

威伦天然色素展位: E3 K10 2号门

E4 原料/Ingredient

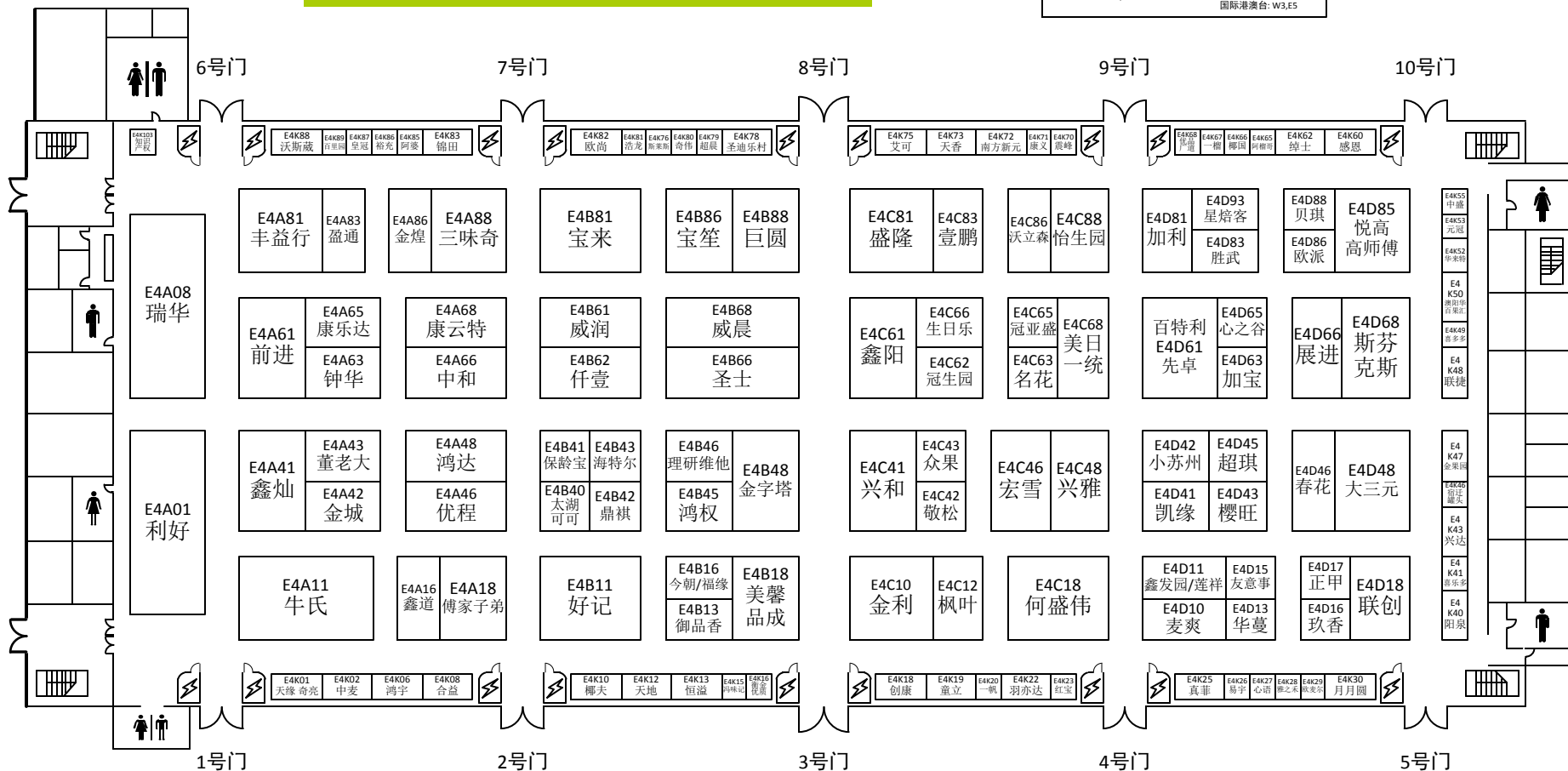
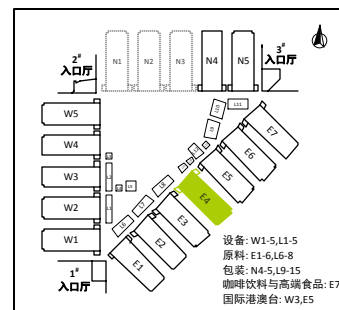



Bakery China

2017第二届中国国际焙烤展览会

2017年5月10-13日(四天) 上海新国际博览中心 (浦东新区龙阳路2345号)
 Date: May 10th-13th,2017 Venue: Shanghai New Int'l Expo Center (SNIEC)

电话: 010-63430880 63430990 传真: 010-63430660
 邮箱: info@bakerychina.com
 网址: www.bakerychina.com

威伦天然色素展位: E3 K10 2号门

E5 原辅料/国际与港澳台展区
 Ingredient/Int'l, HK, Macau & TW Exhibition Area

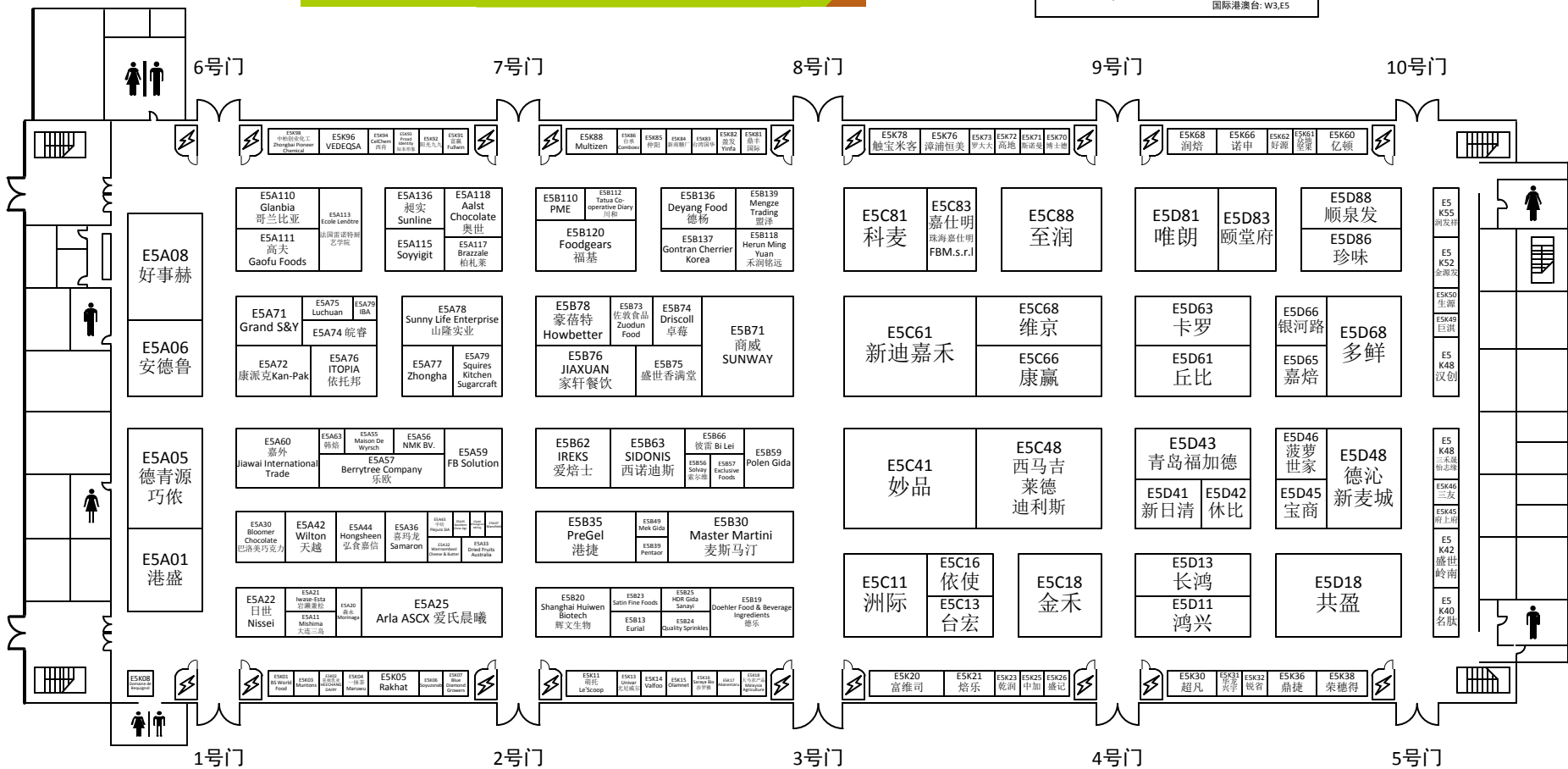
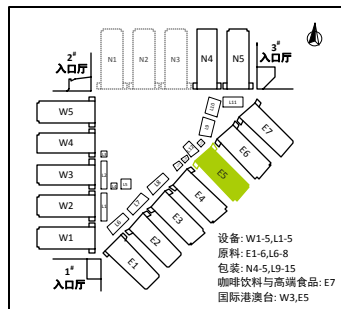



Bakery China

2017第二届中国国际焙烤展览会

2017年5月10-13日(四天) 上海新国际博览中心(浦东新区龙阳路2345号)

Date: May 10th-13th, 2017 Venue: Shanghai New Int'l Expo Center (SNIEC)

电话: 010-63430880 63430990 传真: 010-63430660

邮箱: info@bakerychina.com

网址: www.bakerychina.com

威伦天然色素展位: E3 K10 2号门

E6 原料/Ingredient

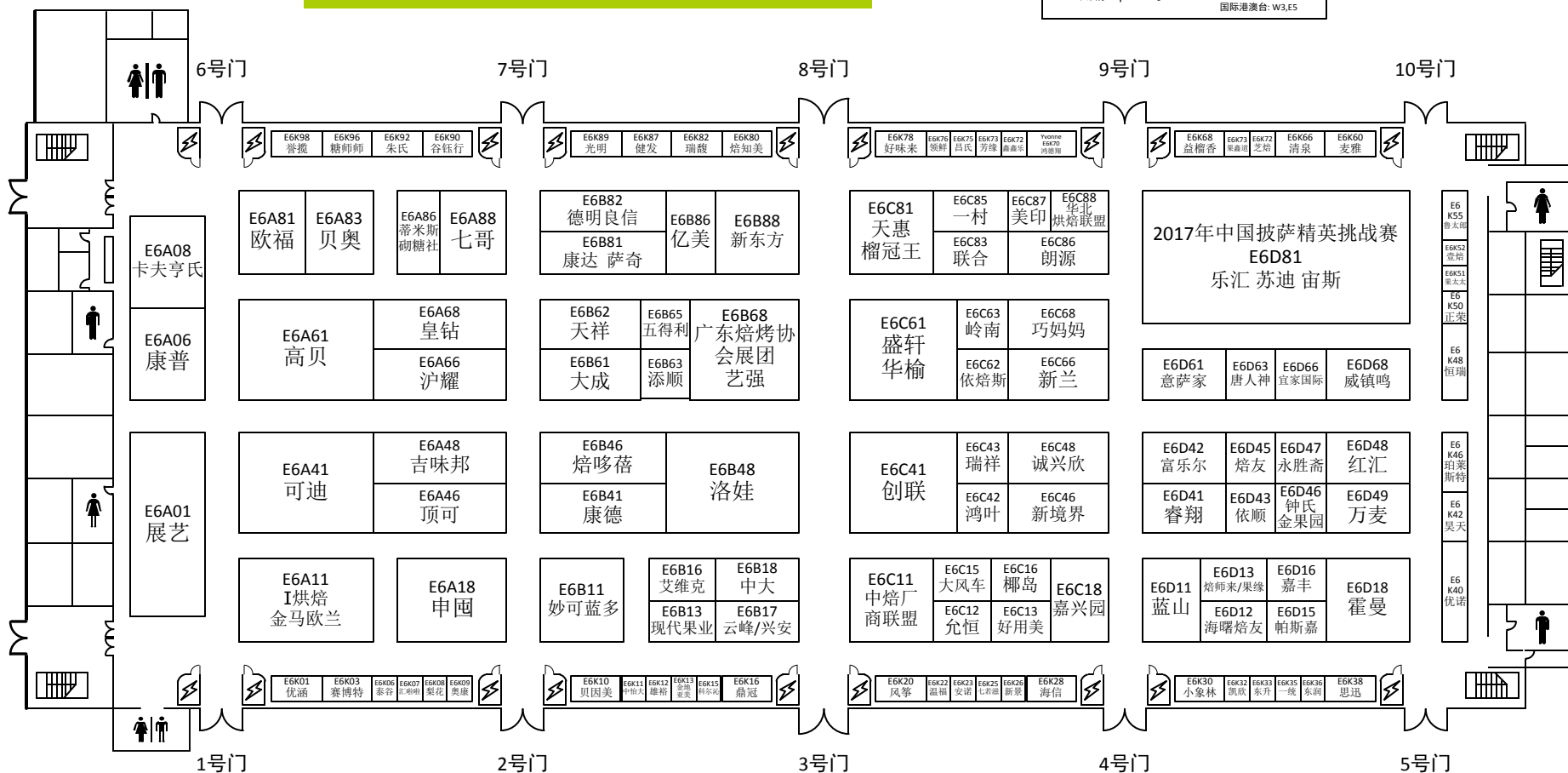
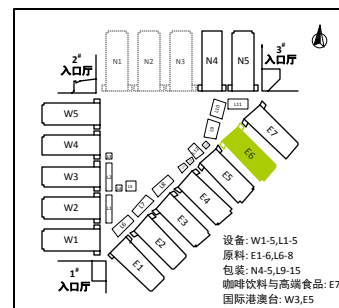



Bakery China

2017第二届中国国际焙烤展览会

2017年5月10-13日(四天) 上海新国际博览中心(浦东新区龙阳路2345号)

Date: May 10th-13th, 2017 Venue: Shanghai New Int'l Expo Center (SNIEC)

电话: 010-63430880 63430990 传真: 010-63430660

邮箱: info@bakerychina.com

网址: www.bakerychina.com

威伦天然色素展位: E3 K10 2号门

E7 咖啡饮料与高端食品
Coffee, Beverage and Fine Food

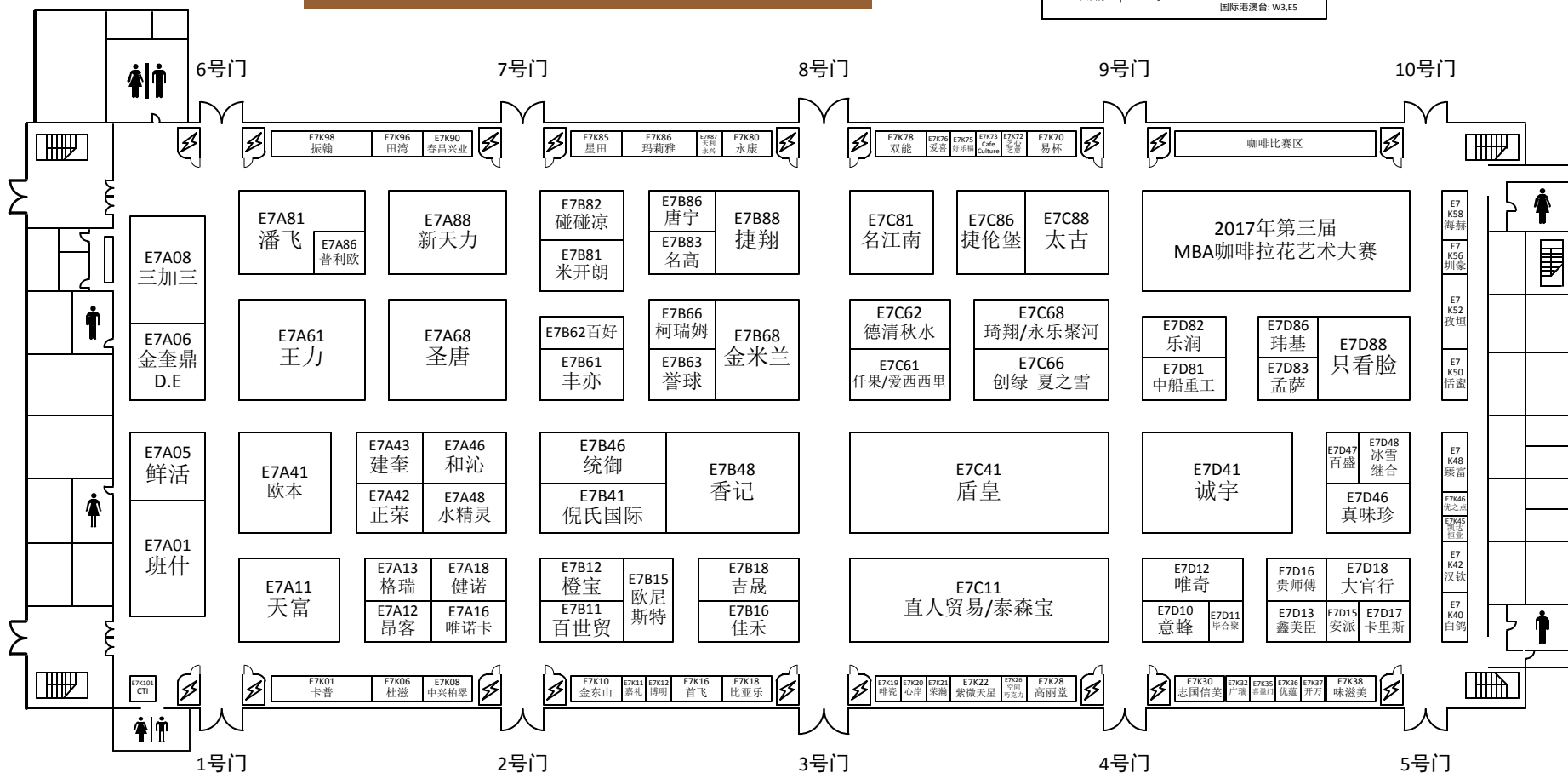
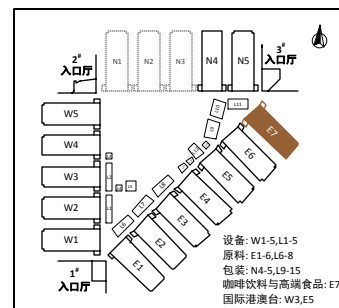



Bakery China

2017第二届中国国际焙烤展览会

2017年5月10-13日(四天) 上海新国际博览中心 (浦东新区龙阳路2345号)

Date: May 10th-13th,2017 Venue: Shanghai New Int'l Expo Center (SNIEC)

电话: 010-63430880 63430990 传真: 010-63430660

邮箱: info@bakerychina.com

网址: www.bakerychina.com

威伦天然色素展位: E3 K10 2号门

L6-8 原料/Ingredient

L6 原料 Ingredient

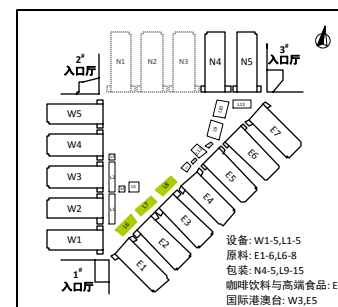
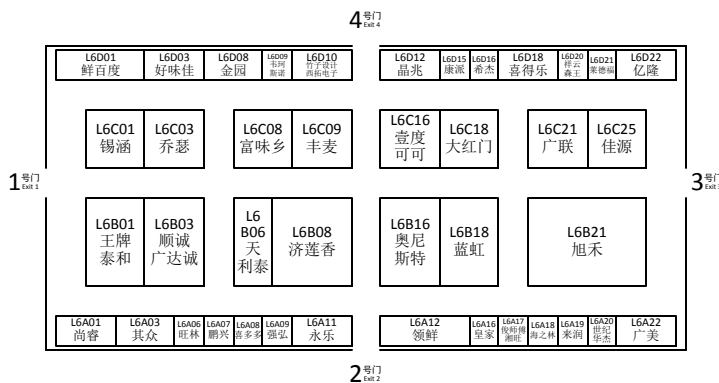

L7 原料 Ingredient

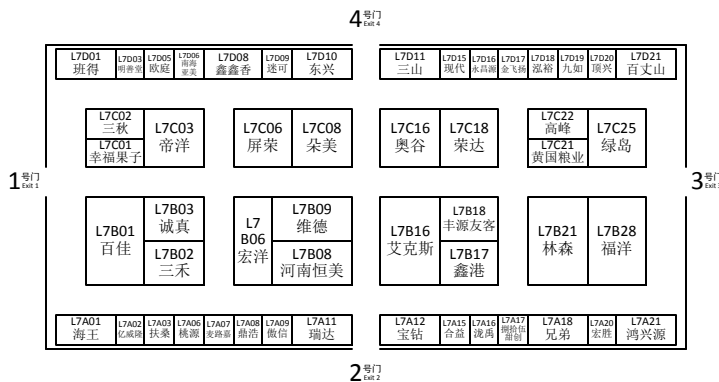

L8 原料 Ingredient

